

INSTALLATION GUIDE

INSTALLATION VALVES



VR 40
VR 95
VR 200

1. GENERAL	3
1.1. APPLICATIONS.....	3
1.2. OPERATING PRINCIPLE.....	3
2. SAFETY	4
3. TECHNICAL SPECIFICATIONS	5
4. INSTALLATION	7
4.1. MEASUREMENTS FOR THE HOUSING.....	7
4.2. INSTALLATION AND ADJUSTMENT.....	8
4.3. HYDRAULIC FLUIDS.....	8
5. MANUFACTURERS LIMITED WARRANTY	9
6. PRODUCT DISPOSAL	10
7. DECLARATION OF CONFORMITY	11

1. GENERAL

1.1. APPLICATIONS

DYNASET VR oil flow limiter valves are designed for reliable hydraulic fluid flow control. With them you keep the flow constant and your hydraulic appliances working properly.

DYNASET VR Pressure compensated oil flow limiter provides fast control of hydraulic flow. They are designed for use in LS-hydraulic systems with several simultaneously running executors.

Outlet flow rate is independent from the pressure and viscosity. The flow rate is determined by a fixed measuring sensor. DYNASET VR Oil flow limiter is pre-adjusted at the factory.

The basic DYNASET VR Oil flow limiter is a flow limiting cartridge valve, which can be fitted into different control blocks or housings.

1.2. OPERATING PRINCIPLE

DYNASETVR are fixed orifice valves with back-up differential pressure compensator for hydraulic systems.

The oil flow sensor determines the flow adjustment range. The flow from inlet A to the outlet B in the valve is specified by a pressure drop in the oil flow sensor. The compensating spool moves into control position which corresponds to the equilibrium created between the oil flow sensor and spring force.

As the flow rate increases the diameter of the control flow opening is reduced in accordance with increased pressure drop, until the oil flow sensor and the spring are in equilibrium again.

Due to the continuous adjustment of the compensating spool in accordance with the prevailing pressure drop, a constant flow is ensured.

When the flow moves from B to A the VR works as an orifice.

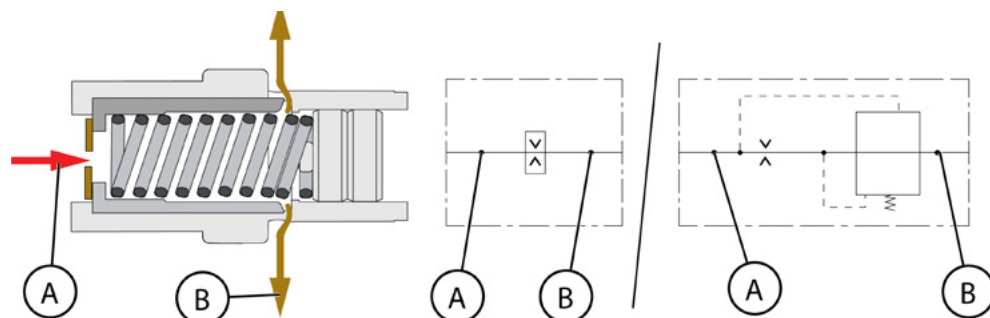

2. SAFETY

ATTENTION!

Operator and maintenance personnel must act in compliance with the laws, regulations and recommendations issued by the local work safety authorities.

 **WARNING**

HIGH PRESSURE OIL!

Can cause severe injuries.
Always wear appropriate clothing and safety equipment.



The pressure in hydraulic circuits is considerably high. Therefore the condition of your equipment are to be kept under constant observation. All couplings, valves and hoses are to be kept tight and clean. Leaks in the hydraulic system must be repaired immediately to avoid injuries caused by high pressure and oil blowouts.

 **WARNING**

RISK OF BURNS!

Parts of the unit, oil, and oil filler cap can be hotter than 80 °C!

Wear personal safety equipment!



ATTENTION!

Before beginning any maintenance, repair or disassembly to the hydraulic system and DYNASET product, ensure that the system is stopped and depressurized. Make sure that the system can not start accidentally.

NOTE!

When carrying out any maintenance to DYNASET unit and the hydraulic system keep the components clean. This is to ensure safe, reliable and longlife operation of your equipment.

When working with DYNASET unit or its accessories, wear appropriate protective clothing, safety goggles, gloves, ear protection.

3. TECHNICAL SPECIFICATIONS

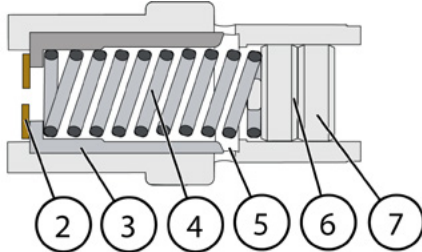

DYNASET VR valve has following components

- | | |
|--------------------|---------------------|
| 1. Oil flow sensor | 4. Control opening |
| 2. Control spool | 5. Adjustment screw |
| 3. Spring | 6. Locking nut |

FLOW RATE (Q) DEPENDENCY ON PRESSURE

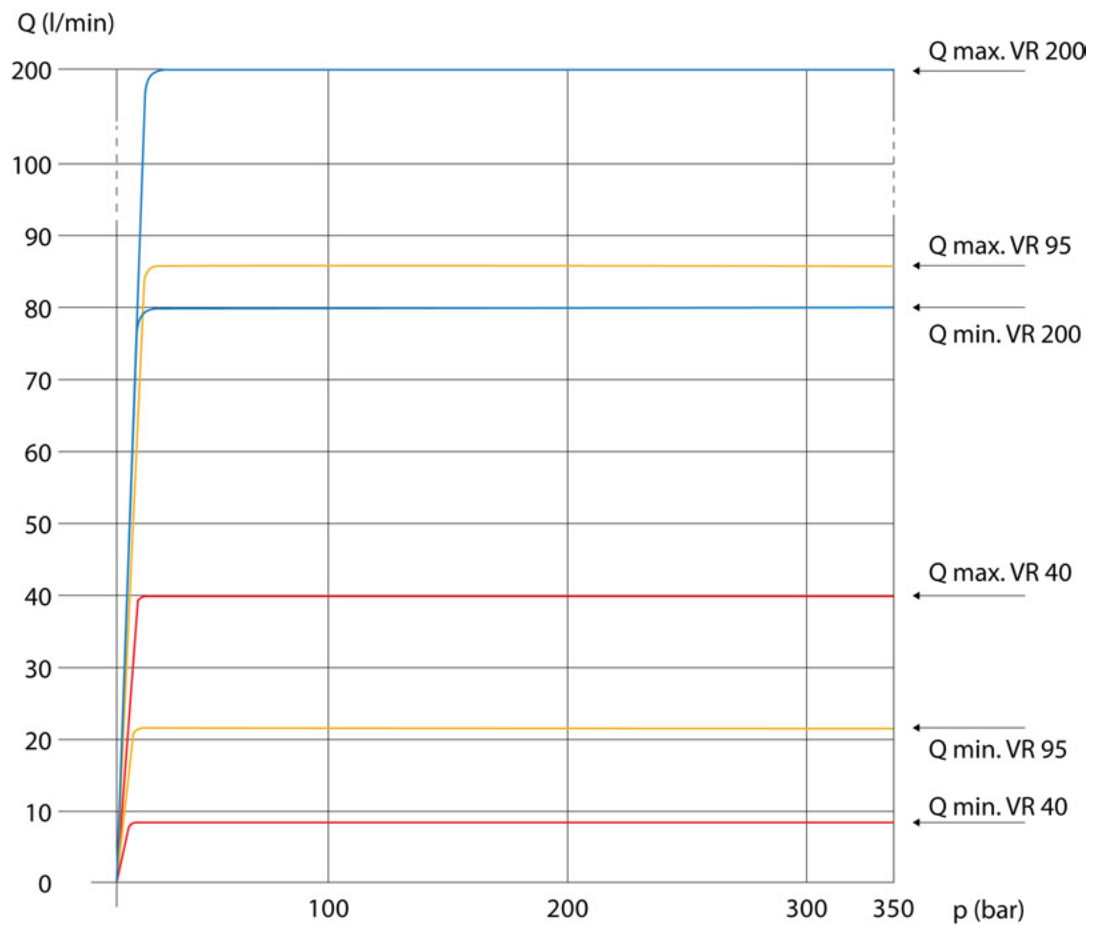

MEASUREMENTS FOR THE VR VALVE

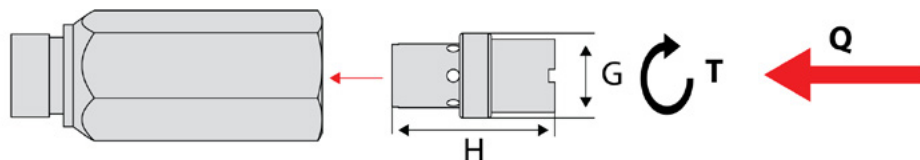

MODEL	p max. bar (psi)	Q CF max.* l/min (gpm)	DIMENSIONS, mm(in)		
			H, mm (in)	G	Weight, g(oz)
VR 40PK-1/2-xxlpm	350 (5100)	40 (10.56)	37(1.46)	BSP 1/2"	49 (1.72)
VR 95PK-3/4-xxlpm	350 (5100)	95 (25.08)	51(2.01)	BSP 3/4"	112 (3.95)
VR 200PK-1-3/4-xxlpm	350 (5100)	200 (52.8)	53(2.09)	BSP 1"	180 (6.35)

*CF value is adjusted at the factory according to the customers specifications.

MODEL	TORQUE, Nm(ft lb)
VR 40PK-1/2-xxlpm	8 - 12 (5.9 - 8.9)
VR 95PK-3/4-xxlpm	12 - 18 (8.9 - 13.0)
VR 200PK-1-3/4-xxlpm	15-20 (11-15)

4. INSTALLATION

4.1. MEASUREMENTS FOR THE HOUSING

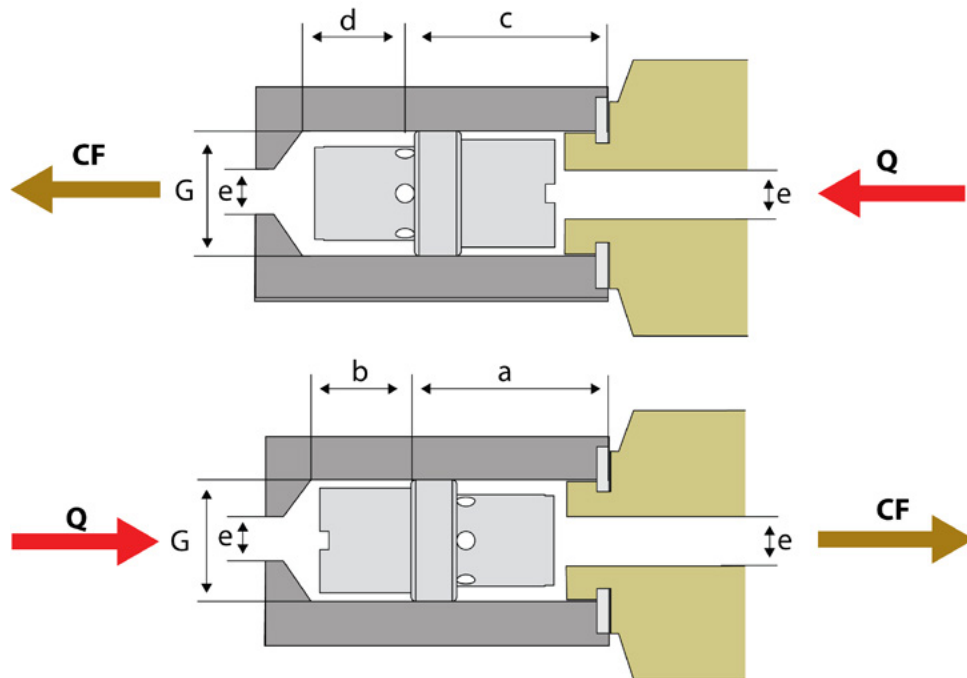

MODEL	DIMENSIONS, mm(in)				
	a min	b min	c min	d min	e min
VR 40PK-1/2-xxlpm	40 (1.58)	15 (0.59)	37 (1.46)	18 (0.71)	10 (0.40)
VR 95PK-3/4-xxlpm	51 (2.01)	24 (0.95)	51 (2.01)	24 (0.95)	12 (0.47)
VR 200PK-1-3/4-xxlpm	51 (2.01)	26 (1.02)	51 (2.01)	26 (1.02)	17 (0.67)

Installation dimensions listed above are minimum values for pipethreads and male threads according to DIN3852.

STANDARD HOUSING FOR THE VR

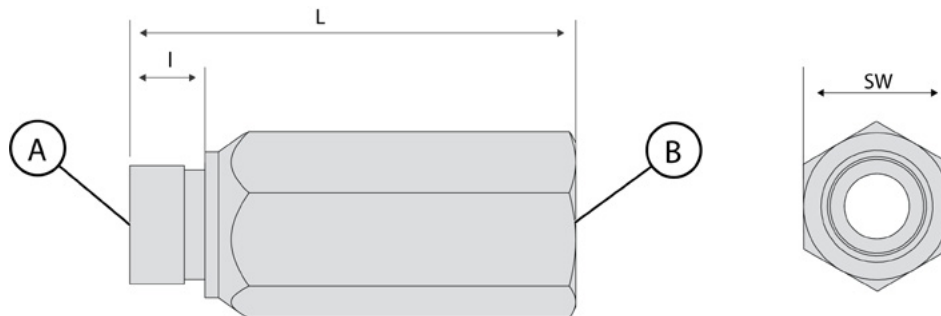

MODEL	CONNECTIONS		HOUSING DIMENSIONS		SW, mm(in)	Weight, g(oz)
	A	B	L	I		
VR 40PK-1/2-xxlpm	BSP 1/2"	BSP 1/2"	82(3.23)	14 (0.55)	27 (1.06)	200 (7.06)
VR 95PK-3/4-xxlpm	BSP 3/4"	BSP 3/4"	98(3.86)	16 (0.64)	36 (1.42)	430 (15.2)
VR 200PK-1-3/4-xxlpm	BSP 3/4"	BSP 1"	102(4.02)	17(0.67)	41(1.61)	500(17.6)

4.2. INSTALLATION AND ADJUSTMENT

Install the VR valve into the control block. If the VR comes in the housing, install it into to desired place in your hydraulic system.

4.3. HYDRAULIC FLUIDS

Hydraulic fluid temperature range is -20 °C to +80 °C (0 °F to 180 °F)
Viscosity range 2,8mm²/s - 380 mm²/s

Wide range of standard hydraulic fluids can be used with the DYNASET hydraulic equipment. Depending on the operating temperature, following mineral hydraulic oils are recommended:

MINERAL HYDRAULIC OIL	OPERATION TEMPERATURE UP TO
ISO VG 32	60 °C (140 °F)
ISO VG 46	70 °C (160 °F)
ISO VG 68	80 °C (175 °F)

Synthetic and bio oils can also be used if their viscosity characteristics and lubricating efficiency are corresponding to the mineral oils.

Automatic transmission fluids and even engine oils can be used, provided that they are allowed to be used in the hydraulic system of your base machine.

Hydraulic fluid change interval is according to the base machine's maintenance instructions. To use special hydraulic fluid with DYNASET equipment, please contact nearest DYNASET representative for an advice.

5. MANUFACTURERS LIMITED WARRANTY

1. Warranty coverage

All hydraulic accessories manufactured by DYNASET OY are subject to the terms and conditions of this limited warranty. Products are warranted to the original purchaser to be free from defects in materials or workmanship. Exclusions from warranty are explained in item Exclusions from warranty.

2. Beginning of warranty period

Warranty period begins from the delivery date of the product. Delivery is considered to be done on the date when installation has been accomplished or purchaser has taken the product in use. Product is considered as taken in use at the date when DYNASET OY has delivered the product to purchaser, unless separately agreed otherwise by written agreement.

3. Warranty period

Warranty period is twenty four (24) months based on maximum of 2000 hours usage during this time period. In cases where the system is provided complete with certain special components (e.g. drive unit), those components are considered as a subject to their manufacturer's warranty.

4. Warranty procedures

Immediately upon identifying a problem which purchaser believes to be a failure subject to the product's limited warranty, purchaser must contact primary to the seller of the product. Contact must be made as soon as possible, latest thirty (30) days after the problem was identified. Seller and/or manufacturer technical staff determines the nature of the problem primarily by phone or e-mail. Purchaser commits to give necessary information and to perform routine diagnostic procedures in order to determine the nature of the problem and necessary procedures.

5. Warranty repairs

If the product is found to be defective during the warranty period, DYNASET OY will, at its option, either repair the product, author it to be repaired at its authorized workshop or exchange the defective product. If the product must be repaired elsewhere than premises of DYNASET OY or authorized workshop, all costs excluded from this warranty (traveling and waiting hours, daily allowance, traveling expenses and uninstallation/reinstallation costs) will be charged from the purchaser.

If the problem is not covered by this limited warranty, DYNASET OY has the right to charge purchaser of troubleshooting and repairing.

6. Delivery terms of warranty repair

If the product is found possible to be defective under this limited warranty and it needs to be repaired, DYNASET OY gives Warranty Return Number (WRN). Items being returned must be shipped, at the purchaser's cost, adequately packed for shipment, to the DYNASET OY or to other location authored by DYNASET OY.

Shipment documents must contain:

Purchaser's name and contact information

Receipt of original purchase

WRN code

Problem description

7. Warranty of repaired product

Warranty period of the product repaired under this limited warranty continues to the end of original warranty period.

8. Exclusions from warranty

This warranty shall not apply to:

- Failures due to normal wear and tear, improper installation, misuse, abuse, negligence, purchaser selection of improper product to intended use, accident, improper filtration of hydraulic oil or intake water or lack of maintenance.
- Cost of maintenance, adjustments, installation or startup.
- Coating, hydraulic oil, quick couplings and interconnection hoses (internal or external to system assemblies).
- Products altered or modified in a manner not authorized by DYNASET OY in writing.
- Products which have been repaired during warranty period by others than DYNASET OY or its authorized workshop.
- Costs of any other damage or loss, whether direct, indirect, incidental, special or consequential, arising out of the use of, or the inability to use, the product.
- Telephone or other communications expense.
- Product that is used in exceptional conditions, considered to cause excessive wear and tear.
- Faults caused by nature phenomenon's like flood, thunder, etc.

© DYNASET OY, all rights reserved

6. PRODUCT DISPOSAL

Dispose and recycle all the DYNASET products and their packaging environmentally responsible way.

Do not dispose used oils, electrical components, batteries or any other hazardous waste with normal waste. They are harmful for the environment and can be recycled for re-use.

Contact your local waste recycling facility for more information about recycling hazardous waste.

NOTE!

Always act according to the waste legislation, regulations and recommendations in waste disposal and waste recycling issued by your local authorities.

7. DECLARATION OF CONFORMITY

We hereby declare that the design and manufacture of the product stated below are in conformity with the provisions of the European Parliament and Councils on the harmonization of the laws of Member States on the safety of machine's.

Machine directive 2006/42/EC

Applied conformity standards:

CEN EN ISO 4413: EN ISO 4413:2010 Hydraulic fluid power - General rules and safety requirements for systems and their components.

Manufacturer: **DYNASET Oy**
Menotie 3, FI-33470 Ylöjärvi, Finland

Product group: INSTALLATION VALVES

Product: VR Oil flow limiting valves

If the device has been modified by someone other than the manufacturer or without the manufacturer's permission, this declaration is not valid.



Timo Nieminen
R&D Manager
Ylöjärvi, Suomi, 1.12.2015



Menotie 3
33470 Ylöjärvi
puh. +358 3 3488 200
info@DYNASET.com



ELECTRICITY

HG Hydraulic Generator
HGV POWER BOX Variable Hydraulic Generator System
HGV Variable Hydraulic Generator System
HWG Hydraulic Welding Generator
HGG Hydraulic Ground Power Generator



HIGH PRESSURE WATER

HPW Hydraulic High Pressure Water Pump
HPW Hydraulic Power Washer
KPL High Pressure Street Washing Unit
HPW-DUST High Pressure Dust Suppression System
PPL High Pressure Pipe Cleaning Unit
HPW-FIRE High Pressure Firefighting System
FP Fire Fighting Piercing Kit
HDF Hydraulic Drilling Fluid Pump
JPL High Pressure Bin Washing System
HSP Hydraulic Submersible Pump



COMPRESSED AIR

HK Hydraulic Piston Compressor
HKL Hydraulic Rotary Vane Compressor
HKR Hydraulic Screw Compressor



MAGNET POWER

HMG PRO Hydraulic Magnet Generator
MAG Lift Magnet
HMAG PRO Hydraulic Magnet



VIBRATION

HVB Hydraulic Vibra
HVD Hydraulic Directional Vibra
HRC Hydraulic Reversal Cylinder



POWER BOOSTING

HPI Hydraulic Pressure Intensifier
HPI-C Hydraulic Pressure Intensifier for Cylinder



KNOW-HOW

Hydraulic Power Take-off (PTO)
Hydraulic Power Unit Technology
De-Icing Technology
Installation Valves
HHK Hydraulic Grinder
HV/HVY Hydraulic Winch / Winch Unit

www.DYNASET.com

